

# HiPerFRED<sup>2</sup>

High Performance Fast Recovery Diode  
 Low Loss and Soft Recovery  
 Common Cathode

$V_{RRM} = 400\text{ V}$   
 $I_{FAV} = 2 \times 10\text{ A}$   
 $t_{rr} = 45\text{ ns}$

Part number

**DPG 20 C 400 PB**

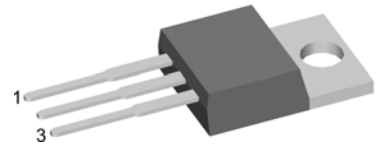
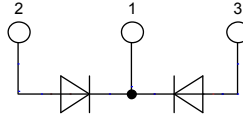

Backside: cathode

### Features / Advantages:

- Planar passivated chips
- Very low leakage current
- Very short recovery time
- Improved thermal behaviour
- Very low  $I_{rm}$ -values
- Very soft recovery behaviour
- Avalanche voltage rated for reliable operation
- Soft reverse recovery for low EMI/RFI
- Low  $I_{rm}$  reduces:
  - Power dissipation within the diode
  - Turn-on loss in the commutating switch

### Applications:

- Antiparallel diode for high frequency switching devices
- Antisaturation diode
- Snubber diode
- Free wheeling diode
- Rectifiers in switch mode power supplies (SMPS)
- Uninterruptible power supplies (UPS)

### Package:

- Housing: TO-220
- Industry standard outline
- Epoxy meets UL 94V-0
- RoHS compliant

### Ratings

Symbol	Definition	Conditions	Ratings			Unit
			min.	typ.	max.	
$V_{RRM}$	max. repetitive reverse voltage				400	V
$I_R$	reverse current	$V_R = 400\text{ V}$			1	$\mu\text{A}$
		$V_R = 400\text{ V}$			0.15	mA
$V_F$	forward voltage	$I_F = 10\text{ A}$			1.32	V
		$I_F = 20\text{ A}$			1.51	V
		$I_F = 10\text{ A}$			1.03	V
		$I_F = 20\text{ A}$			1.24	V
$I_{FAV}$	average forward current	rectangular $d = 0.5$			10	A
$V_{F0}$	threshold voltage				0.77	V
$r_F$	slope resistance					
$R_{thJC}$	thermal resistance junction to case				2.30	K/W
$T_{VJ}$	virtual junction temperature		-55		175	$^{\circ}\text{C}$
$P_{tot}$	total power dissipation				65	W
$I_{FSM}$	max. forward surge current	$t = 10\text{ ms}$ (50 Hz), sine			150	A
$I_{RM}$	max. reverse recovery current				4	A
		$I_F = 10\text{ A}; V_R = 270\text{ V}$			6	A
$t_{rr}$	reverse recovery time	$-di_F/dt = 200\text{ A}/\mu\text{s}$			45	ns
					65	ns
$C_J$	junction capacitance	$V_R = 200\text{ V}; f = 1\text{ MHz}$			12	pF

Symbol	Definition	Conditions	Ratings			Unit
			min.	typ.	max.	
$I_{RMS}$	RMS current	per terminal <sup>1)</sup>			35	A
$R_{thCH}$	thermal resistance case to heatsink			0.50		K/W
$T_{stg}$	storage temperature		-55		150	°C
<b>Weight</b>				2		g
$M_D$	mounting torque		0.4		0.6	Nm
$F_C$	mounting force with clip		20		60	N

<sup>1)</sup>  $I_{RMS}$  is typically limited by the pin-to-chip resistance (1); or by the current capability of the chip (2).  
 In case of (1) and a common cathode/anode configuration with a non-isolated backside, the current capability can be increased by connecting the backside.

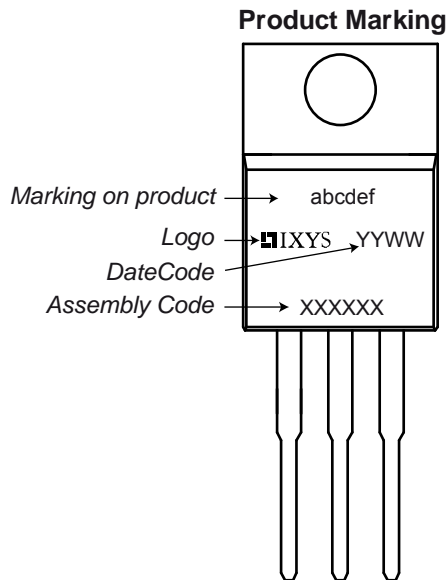
**Part number**

- D = Diode
- P = HiPerFRED
- G = extreme fast
- 20 = Current Rating [A]
- C = Common Cathode
- 400 = Reverse Voltage [V]
- PB = TO-220AB (3)

Ordering	Part Name	Marking on Product	Delivering Mode	Base Qty	Code Key
Standard	DPG 20 C 400 PB	DPG20C400PB	Tube	50	506647

Similar Part	Package	Voltage Class
DPG20C400PN	TO-220ABFP (3)	400
DPG20C400PC	TO-263AB (D2Pak)	400

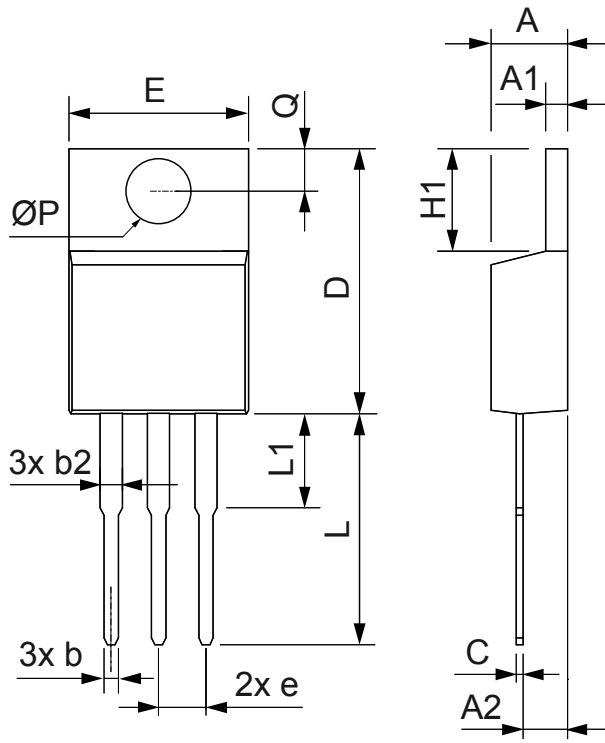
**Outlines TO-220**

Dim.	Millimeter		Inches	
	Min.	Max.	Min.	Max.
A	4.32	4.82	0.170	0.190
A1	1.14	1.39	0.045	0.055
A2	2.29	2.79	0.090	0.110
b	0.64	1.01	0.025	0.040
b2	1.15	1.65	0.045	0.065
C	0.35	0.56	0.014	0.022
D	14.73	16.00	0.580	0.630
E	9.91	10.66	0.390	0.420
e	2.54	BSC	0.100	BSC
H1	5.85	6.85	0.230	0.270
L	12.70	13.97	0.500	0.550
L1	2.79	5.84	0.110	0.230
$\varnothing P$	3.54	4.08	0.139	0.161
Q	2.54	3.18	0.100	0.125

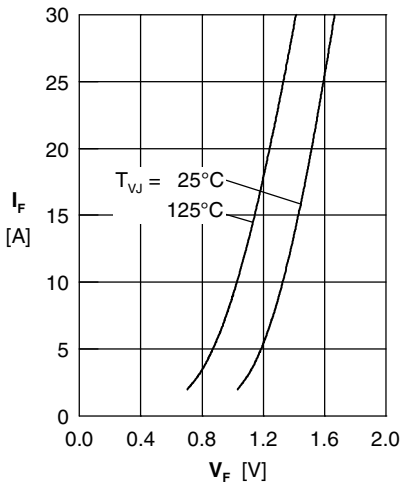

Fig. 1 Forward current  $I_F$  versus forward voltage drop  $V_F$

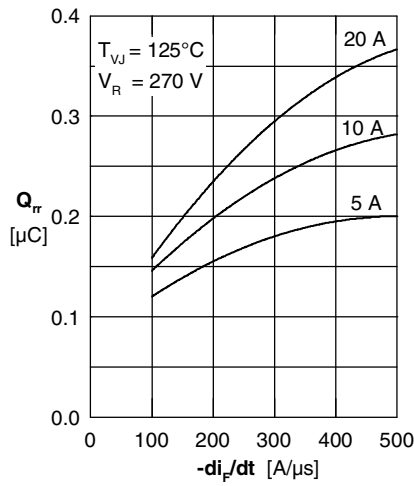

Fig. 2 Typ. reverse recovery charge  $Q_{rr}$  versus  $-di_F/dt$

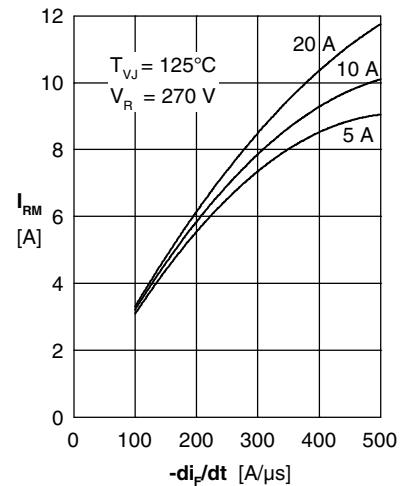

Fig. 3 Typ. reverse recovery current  $I_{RM}$  versus  $-di_F/dt$

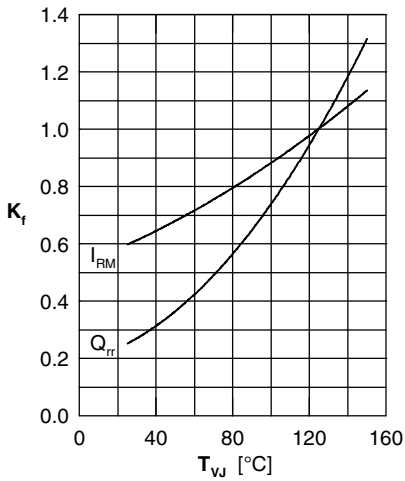

Fig. 4 Dynamic parameters  $Q_{rr}$ ,  $I_{RM}$  versus  $T_{VJ}$

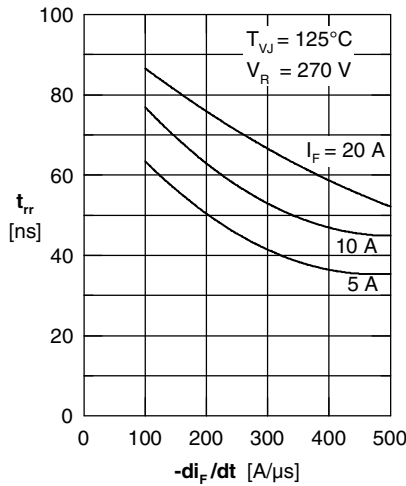

Fig. 5 Typ. reverse recovery time  $t_{rr}$  versus  $-di_F/dt$

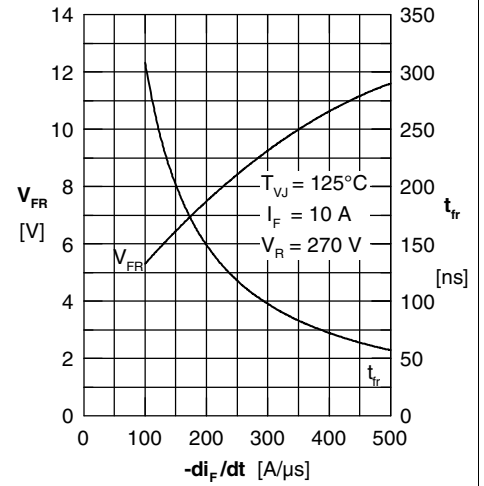

Fig. 6 Typ. forward recovery voltage  $V_{FR}$  and  $t_{fr}$  versus  $di_F/dt$

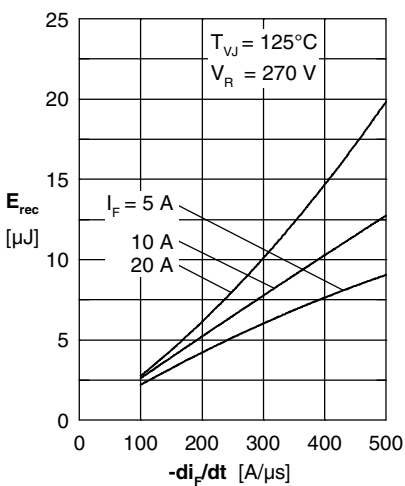

Fig. 7 Typ. recovery energy  $E_{rec}$  versus  $-di_F/dt$

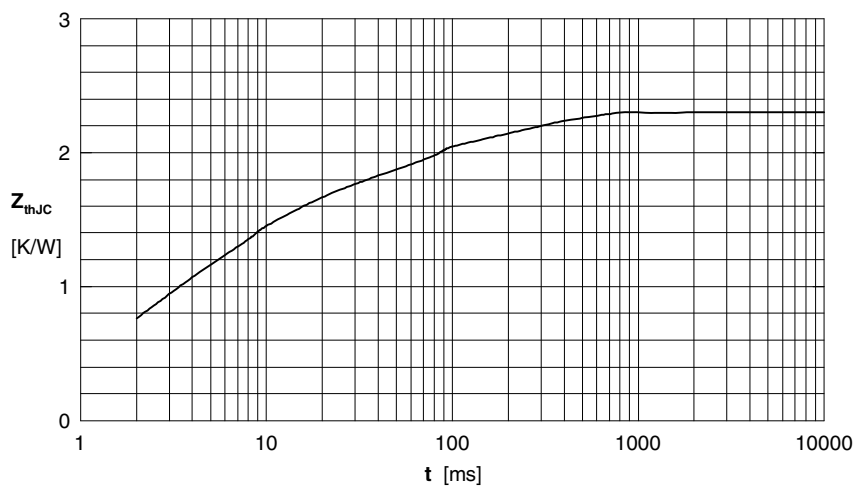

Fig. 8 Transient thermal resistance junction to case